

TCD Series Digital Force Testers

Specification Sheet

SS-FM-3001-0608

June 2008

The CHATILLON® TCD Series is an advanced force testing system optimized for production, quality control and engineering applications. The TCD System consists of a powerful, yet easy-to-use console; a rugged frame and an intelligent load sensing system with measuring accuracies better than 0.1% full scale. The TCD console features a high resolution color graphical display featuring menus, function and numeric keys and status indicators that assist the user in setup, operation and analysis. Information may be displayed in large-format tabular and graphical formats for easy viewing. The frame employs an advanced closed-loop PID controller for precision travel (accuracy better than 0.25% unloaded), ideal for applications such as spring testing where exact distance control is required. The TCD System permits the user to measure heights based on a datum or absolute position. Deflection compensation is standard. Standard test setups for load limits, distance limits, time limits, break tests, rupture tests, cycling and loop tests are included. No computer software is necessary.



Features

- Advanced Yet Simple to Use Test Setups
 - Limit Testing (Load, Distance, Time)
 - Break Testing
 - Cyclic & Loop Testing
 - Multi-Stage/User Defined Testing
 - Height Measurement
- Advanced Operator Control Console
 - Simple Operation: Menus, Templates, Prompts
 - Secure Access
 - Tabular and Graphical Results
 - Embedded SPC
 - Ergonomic Design
 - Large, Color Display
 - No Computer Required
- PID Closed-Loop Motion Control
 - Precision Position Accuracy
 - Speed Accuracy Better than 1%
- 1000Hz Data Sampling and USB Output
 - Save Data to Flash Drive
 - Export Data Directly to Excel or OLE2 Formats
- Large Working Area
 - Ideal for Large and Small Samples
 - T-Slot Table Design Supports Custom Fixturing
- Barcode Automatic Operation
- 1 Year Warranty



Quality Assured.



TCD Specifications

	TCD110 Series	TCD225 Series
Load Capacity	110 lbf, 50 kgf, 500 N	225 lbf, 100 kgf, 1 kN
Maximum Speed (per min)	20 in, 510 mm	50 in, 1270 mm
Minimum Speed (per min)	0.001 in, 0.02 mm	0.001 in, 0.02 mm
Return Speed	User- Selectable	User- Selectable
Crosshead Travel	15.0 in, 380 mm	20.0 in, 510 mm
Instrument Weight (approx.)	65 lbs, 30 kg	75 lbs, 34 kg
Shipping Weight (approx.)	86 lbs, 39 kg	96 lbs, 43 kg

Common Specifications

Load Measurement System

- TLC Series Load Sensors
- Auto-Recognition, "Plug & Test"
- Sensor Overload History Log

Load Measurement System

- Accuracy better than 0.1% Full Scale
- Calibrate On-site to Better than 0.25% Reading
- Measuring system meets or exceeds the following:
ASTM E4, BS 1610, DIN 51221, ISO 7500-1, EN 10002-2, AFNOR A03-501 (*AMETEK recommends system verification on-site at the time of installation by an authorized Chatillon Representative, as required by ASTM E4 and ISO 7500-1*)

Strain Measurement System

- Position accuracy better than 0.001 in (0.02mm) or 0.05% displacement (whichever is greater)
- Strain measurement system meets or exceeds the following:
ASTM E83, BS 3846, ISO 9513, EN 10002-4
- Deflection Compensation Standard

Speed Accuracy

- Better than 1% Full Scale

Distance Accuracy

- Better than 0.25% of reading unloaded

Display Language Options

- English
- Chinese (Simplified & Traditional)
- French
- German
- Korean
- Portuguese
- Russian
- Spanish
- Turkish

These specifications were developed in accordance with AMETEK's standard procedures and are subject to change without notice.

Data Sampling

- 1000Hz
- User Selectable Sampling/Filters (1-1000 Hz)

Data Output

- USB Serial Data and RS232 Data Output
- Save Data Directly to USB Flash Drive
- Interface to USB Serial Devices, e.g. Barcode Scanner/Reader, Printers, Keyboards, Hubs
- Export Data to Excel or any OLE2 Compatible Platform
- Save Test Results Locally in Console Memory

Test Setups

- Load Limit
- Distance Limit
- Time Limit
- Break or Rupture
- Cycle or Loop
- Multi-Stage (Define a custom test with multiple stages)

Operating Temperature

- 40°F to 110°F (5°C to 45°C)

Storage Temperature

- 0° to 130°F (-17° to 54°C)

Relative Humidity

- 20% to 85%

Conformance

- The system conforms to all relevant European standards and carries the CE mark.

Single Phase Voltage

- 100, 120, 220 or 240Vac \pm 10%, 47 to 63Hz. Power must be free of spikes, surges, and sags exceeding 10% of the average voltage.

Warranty

- 1 year

Features

Intelligent Universal Interface

The TCD Series console eliminates the need for a personal computer without compromising operational performance and capability. The TCD console serves as the primary operator interface for real-time setup, testing and analysis. A large 5 x 8-inch color graphic screen presents information in a clear, easy-to-read format. Menus and prompts are used during setup to assist the user. Data is displayed in tabular and graphical formats. Color is used to identify key status events or to inform the user of specific events. For example, a load bargraph displays during a test and displays green to indicate the sensor is measuring within its configured range. The bargraph will change to yellow to alert the operator that the sensor is performing near its capacity. The bargraph will change to red when the sensor is at an overload condition.

Function keys are mapped to the display prompts and serve to guide the user during testing and setup. Function keys may be defined by the user to create "shortcuts" or "hot keys" to frequent operations.

Control keys are minimized to key functions and are large with excellent tactile feedback.

Standard Test Setup

The TCD console is used to setup all testing. No computers or software required. The console contains these test categories: Limit Test, Break Test, Cycle Test and Multi-Stage Test.

Limit Testing

You can setup a test based on a load limit, distance limit or time limit in both tensile and compression directions. Results include the load at a distance limit, the distance at a load limit, the load at a time limit, the distance at a time limit, load average based on a time period.

Break Testing

You can perform break (tensile) or rupture (compression) testing. The break is defined as a percentage drop from the peak load measured. Results include the peak load, load at break/rupture, and distance at break/rupture.

Cycle Testing

You may perform cyclic testing based on a cycle count or cycle time. Results include the first peak and last peak as well as detailed cycle information such as cycle time required. A countdown indicator displays the active cycle condition.

Multi-Stage Testing

The multi-stage setup allows the user to configure virtually any type of test setup imaginable. Each part of a test is defined as a "stage". Each stage can be setup with its own independent load or distance characteristic and speed. Multi-stage testing can be used for creep tests, load hold or distance hold tests, insertion/extraction tests, snap-on/off tests or other sophisticated test methods. You can configure a wide range of wave shape methods including sine, triangle, sawtooth, square, ramp and trapezoidal to your test sample. The user has total freedom to create the test movement required for testing their sample without the need for expensive 3rd-party software applications or validation requirements.

Spring Testing

The TCD Series includes a Height Mode of operation ideal for performing sophisticated spring testing and Gage R&R testing. The height mode allows the user to measure the height of the spring prior to the test, perform pre-conditioning (scragging) and then measure the L1 and L2 limits to within 0.1% accuracy. Using the multi-stage function, you can test multiple test points ideal for characterizing a spring. Data sampling at 1000 samples per second can be saved and exported into Excel for analysis and report generation. The ease and simplicity of the TCD System is unmatched.



RESULTS Data

Large format characters make it easy to view your test result. Color is used to denote pass and fail results. Show a tensile test result for Test No. 3 where the break load was 12.40 lbf and distance was 0.877 inches.



Measuring to New Heights

The TCD System can be set up in Height mode to provide exact height measurements of your samples. Ideal for spring testing, the system includes an automatic datum routine that can be used to determine heights based on the datum. Measurement accuracy is better than 0.001 inch (0.02mm).

Ergonomic Design

The TCD Console is mounted on the standard console mounting arm. The console can be located to provide ideal comfort for the user. The console can pivot, tilt, move up or down.

Features

Intuitive Setup Menus

Each standard test setup within the TCD System contains easy-to-understand menus with test-specific attributes that assist the user in test setups. Common test attributes presented in an intuitive format and icons are displayed to provide the user with a graphical representation of their test setup. "Fill-in-the-blank" formats with a List of Values menu makes setup intuitive, simple and fast. Safe guards are used to help ensure that only logical inputs are configured for a given test function.

All test setups are constructed graphically using Stages. The Stage Types are:

- Tensile Stage (Moves crosshead upward)
- Compression Stage (Moves crosshead downward)
- Cycle Stage (Allows you to cycle multiple tensile or compression Stages together)
- Loop Stage (Similar to cycling, loop multiple tensile or compression Stages and obtain results for each Stage)
- Hold Stage (Hold at a Load or a Distance for creep testing, relaxation testing, etc.)
- Zero Stage (Let's you establish multiple zero positions during a test setup)
- Ask Stage (Place user comments and notations within a test setup)

There is *no limit to the number of Stages* that are used to define a test setup. Every Stage has an independent speed, load or distance characteristic that you define.

A list of coefficients are available for all test types. Select the coefficient you want to measure and obtain a result for. Up to **ten (10) coefficients can be measured and displayed**. You can **rename the coefficient** to make the result specific to your application.

Configuration in a "Flash"

Once a TCD System is setup and its test or tests configured by a user, the entire configuration can be saved to a USB Flash Drive. The Flash Drive can be used to upload the configured tests to multiple TCD Systems in seconds. This eliminates the need for the user to have to perform an entire test setup procedure on multiple "like" testers. It also permits you to save the "master" file securely under the control of a supervisor.

Secure Access

The TCD System provides you with the ultimate in security. The TCD console features two levels of user access: supervisor and operator. Both levels may be password protected. The supervisor has complete system access, while an operator may be configured by the supervisor to have access to specified tests or test functions.

The TCD System can also be setup so that the system will only operate when the "required" USB Flash Drive with setup is installed. For example, you can install the test setup on a USB Flash Drive. The Flash Drive is required to be plugged in to the TCD System before the system can be operated. Without the required or correct USB Flash Drive, the system can be configured to be non-operational. Using an inexpensive flash drive with biometrics provides the ultimate in security.

Bar Code Integration

The use of bar code generators and readers can be integrated with your TCD System for security or to ensure that the correct test setup is performed based on a part number, batch, user, etc. A bar code reader can be connected to the TCD System via a USB hub. The user can scan their security badge or a sample's bar code to gain access to the specific test for that sample. Once the bar code is read by the reader, the TCD System displays the associated test setup and the authorized user is then allowed to perform the test.

Saving Data

The TCD System samples at a data rate of 1000 samples per second. This is especially useful when capturing transient events such as the precise break load of a brittle sample. Because the TCD System saves "true" raw data and not interpolated data like other systems, you have precise information to better characterize your material or component. Each test setup may be configured to sample at any sample rate from 1 to 1000 samples per second. Data may be saved to the USB Flash Drive for export to Excel or other OLE2 compatible file formats for analysis.

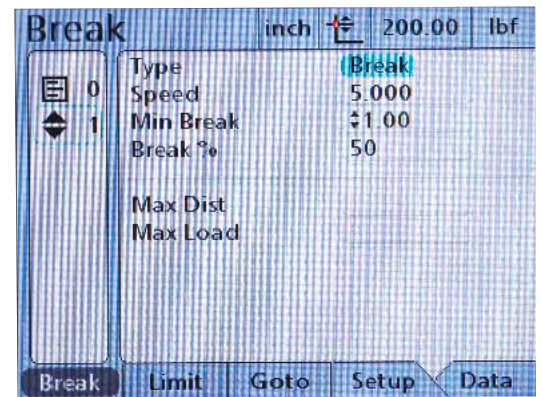

Shown: A simple break test setup menu. Just fill in the blanks and you are ready to test in seconds.

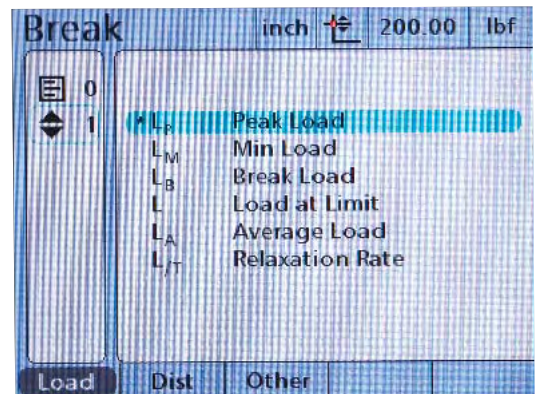

Shown: The available Load coefficients. Select from the list to obtain a measured result for that coefficient.

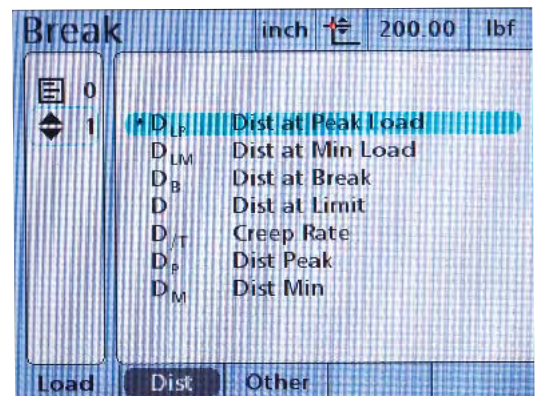

Shown: The available Distance coefficients. Select from the list to obtain a measured result for that coefficient.

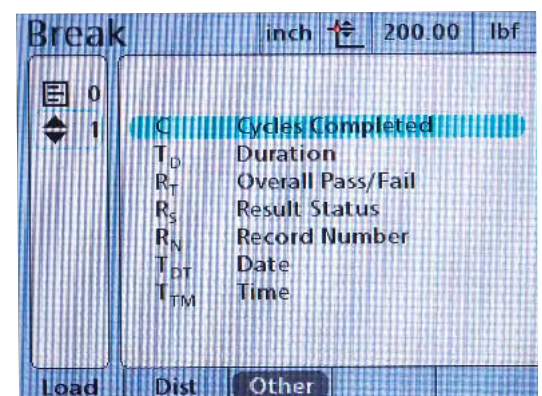

Shown: The available Other coefficients. Select from the list to obtain a measured result for that coefficient.

Features

Comprehensive Result Displays

Once your test is completed, the TCD System will display comprehensive results based on the coefficients you asked for. You can change the size of the result, the order it appears on the display, you can even create multiple screens for your results so that primary results are distinguished from secondary results.

Shown: A Cycle Test result showing the first and last peak load values with distance information. Time duration and number of cycles completed are also shown.



Create Tolerances for Your Results

Display results data in a small format showing tolerance (pass/fail) limits. Example shows limits set at 5.00 lbf and 10.00 lbf. Actual break load was outside the limits, therefore the result is displayed in red indicating a failed test.

Shown: A Break Test shows the peak load with respect to the two setpoint limits that define a pass/fail condition.

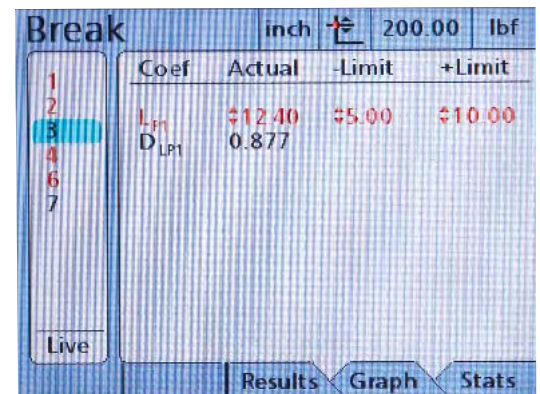

Graph Your Results

Load results data may be graphed based on time and distance. The number of data points that are used to draw the graph are set by the user. Up to 1000 data points may be configured. The navigation keys can be used to display a cross hair. Move the cross hair to view the precise measurement for each data points that was configured. You may output the data points directly into Excel for analysis or to create a more defined graph in a variety of formats.

Shown: A Load v Time graph showing the specific load value and distance values at the cross hair location.

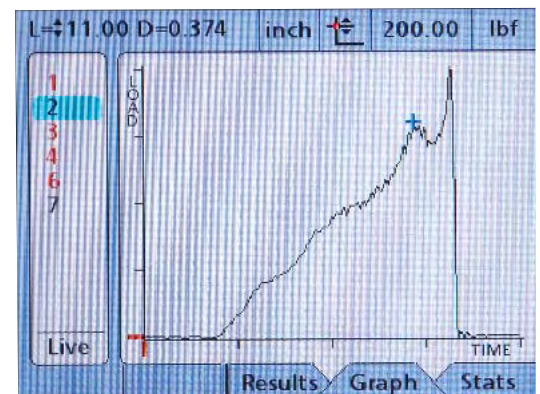

Embedded SPC Calculations

Selecting the STATS soft key shows the statistical results for the test for each coefficient. This display shows the load value (peak load for stage No. 1). The Maximum, Minimum, Range, Average (Mean), Standard Deviation and COV are calculated.

Shown: A Break Test's statistical results. Shown is the peak load for Test No. 2. Six tests were completed. Note that Test 5 was deleted by the user. The system maintain the Run history. A "Mark Deletion" option will maintain a deleted record to show that the operator deleted a test. This data is not included in the statistical results.

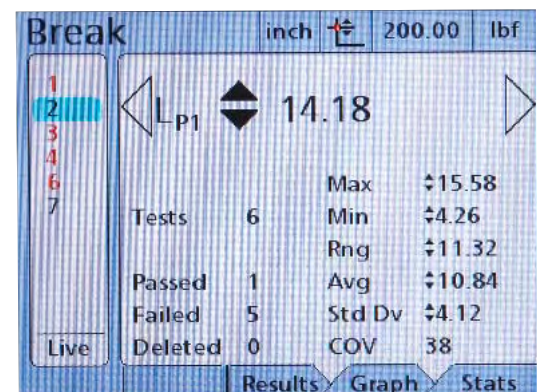

Features

Plug & Play Sensors

The TCD System uses our exclusive Chatillon TLC Series sensor technology. Sensors plug into the TCD Console and the console recognizes and automatically downloads all sensor characteristics. There are also safe guards that can help prevent an operator from using the incorrect sensor on a particular test. Plus the TCD System maintains a load history within memory and can display time-stamped overload events. Seven sensors ranging from 250g (0.5 lb) to 225 lb (100 kg) are available. These same load sensors can also be interchanged with the Chatillon DFS-R-ND Series force gauges. Sensors come standard with a certificate of calibration with NIST data and uncertainty. They can be calibrated to better than 0.1% full scale or 0.5% of indicated reading when calibrated on-site in accordance with ASTM E4 or ISO 7500-1.

Precision Motion Control

The advanced PID loop control used for precise motion control ensures exact positioning of the crosshead. This is especially important when complex demand waveforms are used in your material or component testing. Amplitude control in cyclic waveforms can be controlled precisely to prevent overshooting limits and undershooting peaks.

Touchwheel Precision

In innovative touchwheel is located on the TCD frame and works similar to a personal computer mouse wheel. Rotate the wheel upward causes the crosshead to move upward. Rotate the wheel downward, cause the crosshead to move downward. The speed of the rotation controls the crosshead speed. The touchwheel is ideal for making fine adjustments to your setup prior to conducting your tests, e.g. aligning fixtures, setting a datum, etc.

Over-Travel Limits

Dual over-travel limits, located on the front console, help prevent crosshead overshooting and sensor overloads. A graduated rule along the column can be used to preset these limits to specific distances.

Pinch Load Limits

The TCD System features a Pinch Load capability that allows you to enter a load value up to 15 lbf (7 kgf). When the machine is operated manually using the thumbwheel or DOWN key, the crosshead will stop moving when the system measures the pinch load value. This helps protect the user during a manual move.

Flexible Mounting

The TCD System's T-slot table contains multiple standard through holes for mounting various types of threaded fixtures and eye-end adapters. The fixture mounting block can be easily positioned to ensure proper alignment with the load measuring sensor.

We Speak Your Language

The TCD Console features multiple languages so your operators can perform tests and setups in the language they are most comfortable using. The following language sets are supplied standard:

- English
- Chinese (Traditional)
- Chinese (Simplified)
- French
- German
- Korean
- Portuguese
- Russian
- Turkish

Other languages can be added as required.



Shown: The thumbwheel drive allows you to precisely control crosshead position and speed when in manual mode. This makes fixture preparation and alignment efficient and safe for the user.



Shown: Mechanical travel limits are located on the front of the column. A reference rule is supplied that allows you to accurately locate your maximum travel limits.



Shown: The flexible mounting block with standard accessories. A tray at the back of the machine can be used to store fixtures, adapters, etc.

Dimensions

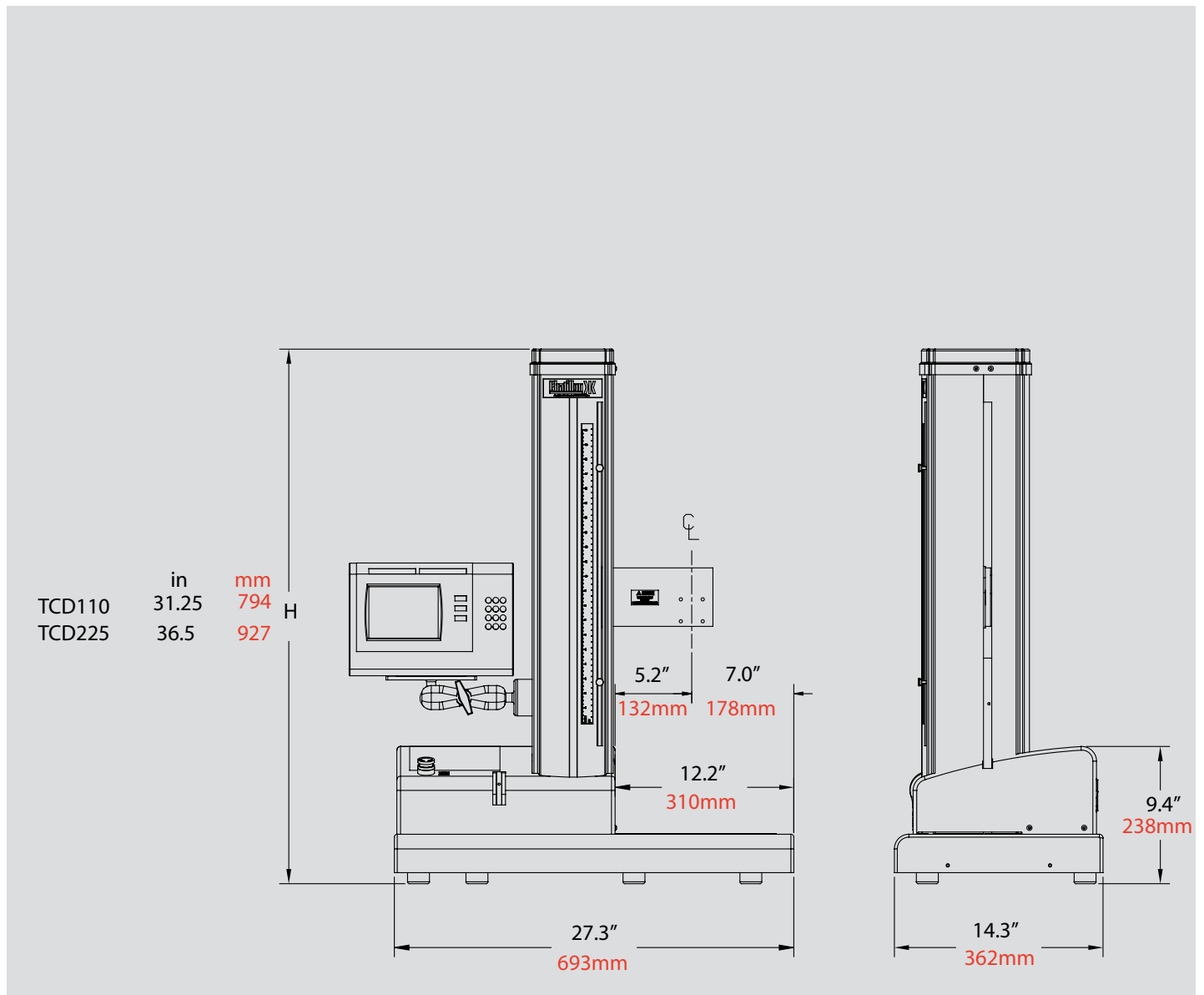

Ordering

TCD110 Force Measuring Systems

Model	Load Sensor	Description
TCD110-X	None	TCD110 Series Frame with Console
TCD110-250G	TLC-250G	TCD110 Series Frame with Console and Load Sensor
TCD110-0002	TLC-0002	TCD110 Series Frame with Console and Load Sensor
TCD110-0005	TLC-0005	TCD110 Series Frame with Console and Load Sensor
TCD110-0010	TLC-0010	TCD110 Series Frame with Console and Load Sensor
TCD110-0025	TLC-0025	TCD110 Series Frame with Console and Load Sensor
TCD110-0050	TLC-0050	TCD110 Series Frame with Console and Load Sensor
TCD110-0100	TLC-0100	TCD110 Series Frame with Console and Load Sensor

TCD225 Force Measuring Systems

Model	Load Sensor	Description
TCD225-X	None	TCD225 Series Frame with Console
TCD225-250G	TLC-250G	TCD225 Series Frame with Console and Load Sensor
TCD225-0002	TLC-0002	TCD225 Series Frame with Console and Load Sensor
TCD225-0005	TLC-0005	TCD225 Series Frame with Console and Load Sensor
TCD225-0010	TLC-0010	TCD225 Series Frame with Console and Load Sensor
TCD225-0025	TLC-0025	TCD225 Series Frame with Console and Load Sensor
TCD225-0050	TLC-0050	TCD225 Series Frame with Console and Load Sensor
TCD225-0100	TLC-0100	TCD225 Series Frame with Console and Load Sensor
TCD225-0200	TLC-0100	TCD225 Series Frame with Console and Load Sensor

Note: Please add suffix "-230V" after the base model number if you will be using your TCD System with a 220 or 240Vac power source. Example: TCD110-0100-230V.

TLC Series Load Sensors

Model	ozf	gf	lbf	kgf	N
TLC-250G	8 x 0.002	250 x 0.05	0.5 x 0.0001	0.25 x 0.0001	2.5 x 0.0005
TLC-0002	32 x 0.005	1000 x 0.1	2 x 0.0002	1 x 0.0001	10 x 0.001
TLC-0005	80 x 0.01	2500 x 0.25	5 x 0.0005	2.5 x 0.0002	25 x 0.002
TLC-0010	160 x 0.02	5000 x 0.5	10 x 0.001	5 x 0.0005	50 x 0.005
TLC-0025	400 x 0.05	10,000 x 1	25 x 0.002	10 x 0.001	100 x 0.01
TLC-0050	800 x 0.1	25,000 x 2	50 x 0.005	25 x 0.002	250 x 0.02
TLC-0100	1600 x 0.2	50,000 x 5	100 x 0.01	50 x 0.005	500 x 0.05
TLC-0200	-	-	200 x 0.02	100 x 0.01	1000 x 0.1

Standard Accessories

Part No.	Description
NC003029	Eye End Adapter, 10-32F ⁽¹⁾
SPK-EYE-2528M	Eye End Adapter, 1/4-28M ⁽²⁾
SPK-FM200-034	Power Cord, US Plug 115V
SPK-FM200-022	Power Cord, EU Plug 230V
SPK-LTCM-UK230	Power Cord, UK Plug 230V
SPK-TCD-048	1G USB Flash Drive
SPK-TCD-042	5/8" Eye End & Locking Rings
NC000612	Grip Pin
SPK-TCD-051	Loadcell Mounting Block

Notes:

⁽¹⁾ Eye End supplied on testers with load sensor up to 25 lbf (100N) capacity

⁽²⁾ Eye End supplied on testers with load sensor above 25 lbf (100N) capacity

About Your TLC Sensor

TLC Sensors are optimized for use with a TCD Series Force Tester. These "plug & play" sensors meet or exceed ASTM E4, BS 1610, DIN 51221, ISO 7500-1, EN 10002-2 and AFNOR A03-501 standards when calibrated on-site by an authorized Chatillon Representative.

Your TLC Sensor will be calibrated to 0.1% full scale from the factory when the sensor is ordered as part of a TCD System. The sensor is supplied with a Certificate of Calibration with NIST data and uncertainty.

Your TLC Sensor will be calibrated to 0.25% full scale from the factory when the sensor is ordered separately. The sensor is supplied with a Certificate of Calibration with NIST data and uncertainty. The sensor can be plugged into your TCD Series Console or to a DFS-R-ND Series force gauge for immediate use. However, if you require a higher accuracy, you must re-calibrate the sensor on the device (TCD Tester or DFS-R-ND Gauge) that the sensor is to be used on. Because the electronics and processing speeds are different on the TCD compared to the DFS gauge, it is important for you to re-characterize the sensor to the mating device each time it is used.



MEASUREMENT & CALIBRATION TECHNOLOGIES

Americas
AMETEK
Measurement & Calibration
Technologies
8600 Somerset Drive
Largo, Florida 33773
United States of America
Tel +1-727-536-7831
Tel +1-800-527-9999
Fax +1-727-539-6882
Email chatillon.fl-har@ametek.com

United Kingdom
Lloyd Instruments Ltd.
12 Barnes Wallis Road
Segensworth East
Fareham
Hants, PO15 5TT
United Kingdom
Tel +44 (0) 1489 486 399
Fax +44 (0) 1489 885 118
Email uk-far.general@ametek.co.uk

France
AMETEK S.A.S.
Rond Point de l'Epine des Champs
Buro Plus - Bat. D
78990 Elancourt
France
Tel +33 (0)1 30 68 89 40
Fax +33 (0)1 30 68 89 49
Email general@lloyd-instruments.com

Germany
AMETEK GmbH
Rudolf-Diesel-Strasse 16
D-40670 Meerbusch
Germany
Tel +49 (0)2159 9136-70
Fax +49 (0)2159 9136-39
Email info@ametek.de

Singapore
AMETEK Singapore Pvt. Ltd.
10 Ang Mo Kio Street 65
#05-12 Techpoint
Singapore 569059
Tel +65-484-2388
Fax +65-481-6588
Email aspl@ametek.com.sg

Visit Us on the Worldwide Web at:
www.chatillon.com

© 2008 by AMETEK, Inc.

Information within this document is subject to change without notice.



ISO 9001:2000
ISO/IEC17025
Manufacturer